



audio-technica

ATH-S220BT

Wireless Headphones

User Manual

English

Safety precautions

Although this product was designed to be used safely, failing to use it correctly may result in an accident. To ensure safety, observe all warnings and cautions while using the product.

Cautions for the product

- Do not use the product near medical equipment. Radio waves may affect cardiac pacemakers and medical electronic equipment. Do not use the product inside medical facilities.
- When using the product in aircraft, follow airline instructions.
- Do not use the product near automatic control devices such as automatic doors and fire alarms. Radio waves may affect electronic equipment and cause accidents due to malfunction.
- Do not disassemble, modify or attempt to repair the product to avoid electric shock, malfunction or fire.
- Do not subject the product to strong impact to avoid electric shock, malfunction or fire.
- Do not handle the product with wet hands to avoid electric shock or injury.
- Disconnect the product from a device if the product begins to malfunction, producing smoke, odor, heat, unwanted noise or showing other signs of damage. In such a case, contact your local Audio-Technica dealer.
- Do not allow the product to get wet to avoid electric shock or malfunction.
- Do not put foreign matter such as combustible materials, metal, or liquid in the product.
- Do not cover the product with a cloth to avoid fire or injury by overheating.
- Follow applicable laws regarding mobile phone and headphone use if using headphones while driving.
- Do not use the product in places where the inability to hear ambient sound presents a serious risk (such as at railroad crossings, train stations, and construction sites).
- When charging, make sure to use the included USB charging cable.
- Do not charge with devices that have quick-charge functionality (with a voltage of 5 V or more). Doing so may cause the product to malfunction.
- To prevent damage to your hearing, do not raise the volume too high. Listening to loud sound for an extended period may cause temporary or permanent hearing loss.
- Discontinue use if skin irritation results from direct contact with the product.
- Do not catch your fingers or other body parts between the housing and the arm or inside the joints.

Cautions for rechargeable battery

The product is equipped with a rechargeable battery (lithium polymer battery).

- If battery fluid gets into eyes, do not rub them. Rinse thoroughly with clean water such as tap water and consult a doctor immediately.
- If battery fluid leaks, do not touch fluid with bare hands. If fluid remains inside the product, it may cause malfunction. If battery fluid leaks, contact your local Audio-Technica dealer.
 - If fluid gets in your mouth, gargle thoroughly with clean water such as tap water and consult a doctor immediately.
 - If your skin or clothing comes in contact with fluid, immediately wash the affected skin or clothing with water. If you experience skin irritation, consult a doctor.

Safety precautions

- To avoid leakage, generation of heat or explosion:
 - Never heat, disassemble or modify the battery, nor dispose of it in a fire.
 - Do not attempt to pierce with a nail, hit with a hammer or step on the battery.
 - Do not drop the product or subject it to strong impact.
 - Do not get the battery wet.
- Do not use, leave or store the battery in the following places:
 - Area exposed to direct sunlight or high temperatures and humidity
 - Inside of a car under the blazing sun
 - Near heat sources such as heat registers
- Charge only with the included USB cable to avoid malfunction or fire.
- The internal rechargeable battery of this product cannot be replaced by the user. The battery may have reached the end of its service life if the usage time becomes significantly shorter even after the battery has been fully charged. If this is the case, the battery needs to be repaired. Contact your local Audio-Technica dealer for repair details.
- When the product is disposed of, the built-in rechargeable battery needs to be discarded properly. Contact your local Audio-Technica dealer to learn how to properly dispose of the battery.

For customers in the USA

FCC Notice

Warning

This device complies with Part 15 of the FCC Rules. Operation is subject to the following two conditions: (1) This device may not cause harmful interference, and (2) this device must accept any interference received, including interference that may cause undesired operation.

Caution

You are cautioned that any changes or modifications not expressly approved in this manual could void your authority to operate this equipment. This transmitter must not be co-located or operated in conjunction with any other antenna or transmitter used in other systems.

RF Exposure Statement

This device complies with FCC radiation exposure limits set forth for an uncontrolled environment and meets the FCC radio frequency (RF) Exposure Guidelines. This equipment has very low levels of RF energy that is deemed to comply without testing of specific absorption rate (SAR).

Contact

Responsible Company: Audio-Technica U.S., Inc.
Address: 1221 Commerce Drive, Stow, Ohio 44224, USA
Tel: 330-686-2600

For customers in Canada

ISED statement

This device contains licence-exempt transmitter(s)/receiver(s) that comply with Innovation, Science and Economic Development Canada's licence-exempt RSS(s). Operation is subject to the following two conditions:

- (1) This device may not cause interference.
- (2) This device must accept any interference, including interference that may cause undesired operation of the device.

This device complies with RSS-102 radiation exposure limits set forth for an uncontrolled environment.

Notes on use

- Be sure to read the connected device's user manual before use.
- Audio-Technica will not be liable in any way for any loss of data in the unlikely event that such losses should occur while using the product.
- On public transportation or in other public places, keep the volume low so as not to disturb other people.
- Minimize the volume on your device before connecting the product.
- When using the product in a dry environment, you may feel a tingling sensation in your ears. This is caused by static electricity accumulated on your body, not by product malfunction.
- Do not subject the product to strong impact.
- Do not store the product in direct sunlight, near heating devices, or in hot, humid, or dusty places. Additionally, do not allow the product to get wet.
- When the product is used for a long time, the product may become discolored due to ultraviolet light (especially direct sunlight) and wear.
- If the product is placed in a bag while the USB charging cable is still connected, the USB charging cable may become caught, severed, or broken.
- Make sure to hold the plug when connecting and disconnecting the USB charging cable. The USB charging cable may become severed or an accident may occur if you pull on the cable itself.
- When you are not using the USB charging cable, disconnect it from the product.
- Do not charge the battery if the terminal of the USB charging cable is bent, loose, or damaged. Doing so may cause heat generation, smoke emission, fire or electric shock.
- This product can be used to talk on the phone only when using a mobile telephone network. Support for telephony apps that use a mobile data network is not guaranteed.
- If you use the product near an electronic device or transmitter (such as a mobile phone), unwanted noise may be heard. In this case, move the product away from the electronic device or transmitter.
- If you use the product near a TV or radio antenna, noise may be seen or heard in the television or radio signal. In this case, move the product away from the TV or radio antenna.
- To protect the built-in rechargeable battery, charge it at least once every 6 months. If too much time passes between charges, the life of the rechargeable battery may be reduced, or the rechargeable battery may no longer be able to be charged.
- Do not charge the product if water or foreign matter is inside the battery jack or USB charging cable. Doing so may cause corrosion, heat generation, smoke, fire, or other malfunction or electric shock in the battery jack or USB charging cable.
- Charge the product in a well-ventilated place (10 to 35°C (50 to 95°F)) away from direct sunlight. Otherwise, the battery may deteriorate, possibly resulting in shorter periods of continuous use or may fail to charge.
- If the product is wet with sweat, wipe off any moisture with a dry cloth before charging.

For a more comfortable Bluetooth communication experience

The effective communication range of this product varies depending on obstructions and radio wave conditions. For a more enjoyable experience, please use the product as close as possible to the Bluetooth device. To minimize noise and sound disruptions, avoid placing your body or other obstacles between the product's antenna (L side) and the Bluetooth device.

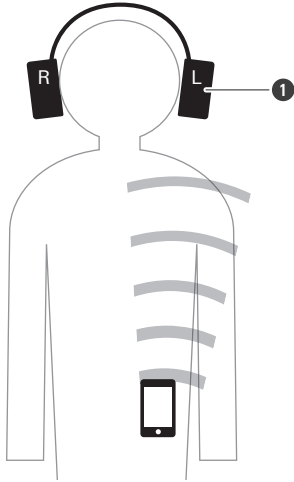

1 Antenna

Part names and functions

Headphones

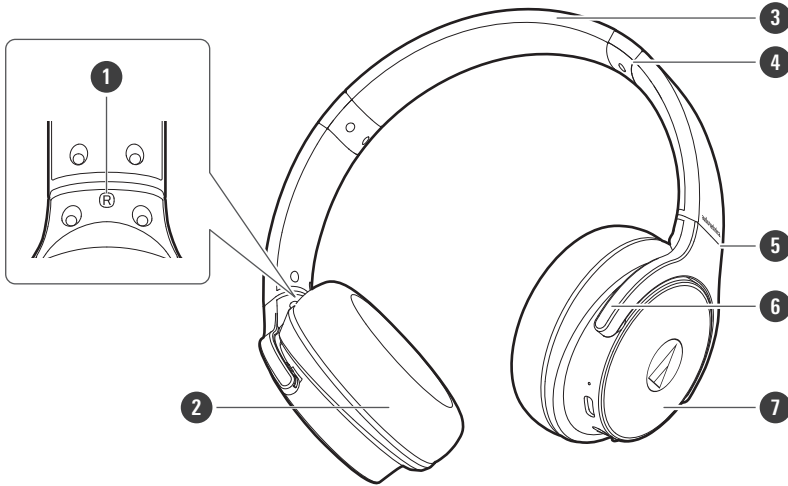

- 1 L/R (left/right) indicator
- 2 Earpad
- 3 Headband
- 4 Slider
- 5 Joint
- 6 Arm
- 7 Housing

Operation area

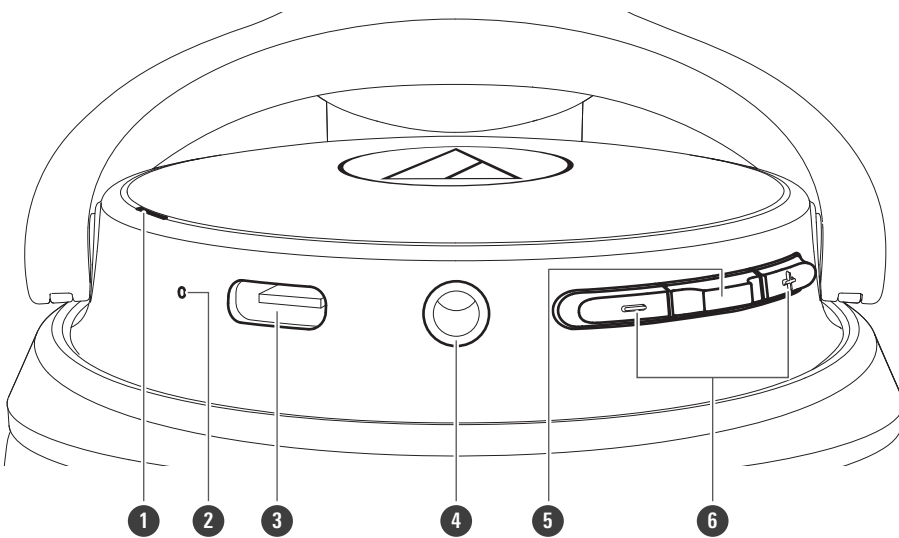

- 1 **Indicator lamp**
Displays the operating status and battery level of the product.

Part names and functions

2 Microphone

3 Battery jack

Use to connect the included USB charging cable and charge the product.

4 Connector jack

Use to connect the included cable for wired connections.

5 Power supply / control button

Use to turn the power supply ON/OFF, play/pause music, and answer phone calls.

6 Volume buttons

Use to adjust the volume up or down (+/-).

Accessories

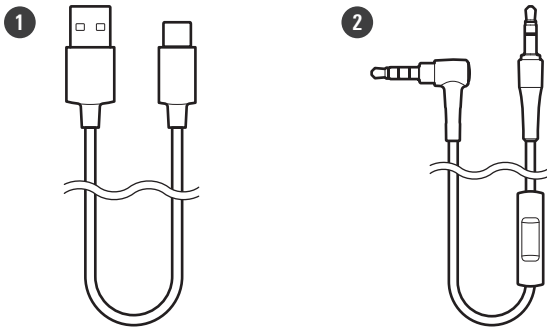

1 USB charging cable (30 cm (12"), USB Type-A / USB Type-C™)

2 Cable with in-line mic and control (1.2 m (3.9') / 3.5 mm (1/8") gold-plated stereo mini-plug (4 pole/L-shaped))

Charging the battery

Fully charge the battery when using for the first time.

When the rechargeable battery is running low, the voice guidance will play the message “Low battery”, and the indicator lamp will flash in red. Charge the battery as soon as possible.

It takes about 4 hours maximum to charge the battery fully. (This time may vary depending on usage conditions.)

Charge the product in a well-ventilated place (10 to 35°C (50 to 95°F)) away from direct sunlight. Otherwise, the battery may deteriorate, possibly resulting in shorter periods of continuous use or may fail to charge.

1 Connect the included USB charging cable (USB Type-C side) to the battery jack.

- The included USB charging cable is designed for exclusive use with the product. Do not use any other USB charging cable.
- When inserting the USB charging cable into the USB port or battery jack, insert it directly (horizontally).

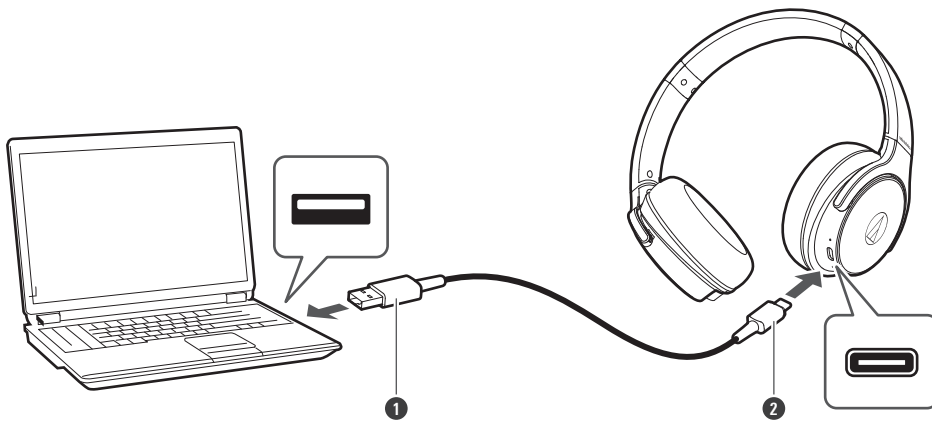

1 USB Type-A

2 USB Type-C

2 Connect the included USB charging cable (USB Type-A side) to the computer to start charging.

- While charging, the indicator lamp lights as follows. (It may take several seconds for the indicator lamp to light.)

Indicator lamp	Status
Lit red	Charging
Off	Charging complete
Flashing red	Charging error ^[1]

[1] The headphones may be hot. Allow the temperature of the product to cool sufficiently before charging in a well-ventilated place (10 to 35°C (50 to 95°F)) away from direct sunlight.

3 When charging is complete, disconnect the USB charging cable (USB Type-A side) from the computer.

4 Disconnect the USB charging cable (USB Type-C side) from the product's battery jack.



- If you start to charge while the product is on, it will automatically turn off.

Charging the battery



- When charging, make sure to use the included USB charging cable. The product may not charge with cables other than the included USB charging cable.

Power supply ON/OFF

Turning on the product

- 1 Press and hold the power supply/control button (about 2 seconds).

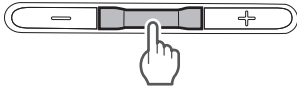

» The indicator lamp lights in white, and then flashes. Voice guidance is played.



- It may take several seconds for the indicator lamp to light.
- See "Voice guidance" (p. 21) for more information on voice guidance.

Turning off the product

- 1 Press and hold the power supply/control button (about 2 seconds).

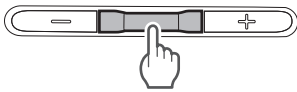

» The indicator lamp lights in white, and then turns off.

Connecting via Bluetooth

To connect the product to a Bluetooth device, the product needs to pair (register) with the device.

Pairing a Bluetooth device

- Read the user manual for the Bluetooth device.
- Place the Bluetooth device within 1 m (3.3') of the product to perform pairing correctly.
- Wear the product to hear voice guidance during pairing.

1 Starting with the product turned off, turn it on.

- The indicator lamp will light in white, and then flash in white.

2 Use your Bluetooth device to begin the pairing process and search for the product. When your Bluetooth device finds the product, "ATH-S220BT" will be displayed on the device.

- For information about using your Bluetooth device, refer to the device's user manual.

3 Select "ATH-S220BT" to pair the product and your Bluetooth device.

- Some devices may ask for a passkey. In this case, enter "0000". The passkey may also be called a passcode, PIN code, PIN number, or password.

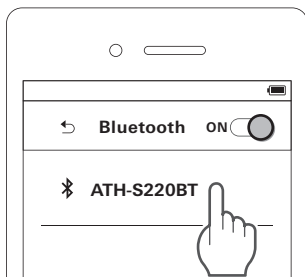

» The voice guidance will play the message "Bluetooth connected", and the indicator lamp will flash slowly in white. This indicates pairing was successfully completed.

Pairing with Fast Pair



In one touch, the product enables quick, effortless Bluetooth pairing with your Android devices. You can even check to see where you last placed it.

Connecting via Bluetooth

1 Turn on the Bluetooth function on an Android device configured with a Google account.

2 Turn on the product and bring the product close to the Android device.

- For information about using your Bluetooth device, refer to the device's user manual.

3 Touch the pairing notification that appears on your Android device.

» The voice guidance will play the message "Bluetooth connected" when pairing is complete. The indicator lamp will begin flashing slowly in white.

About pairing

When connecting a new Bluetooth device, you need to pair it with the product. Once the Bluetooth device and the product are paired, you do not need to pair them again. The product supports multipairing, in which a connection history is saved. However, in the following cases you will need to pair again even if the Bluetooth device was paired once:

- If the product is deleted from the Bluetooth device's connection history.
- If the product is sent out for repair.
- If the product is reset.

Multipoint function

The product supports multipoint, which allows two Bluetooth devices to be connected at the same time. While you are listening to music with one device, you can answer a call that comes in from the other device. It is convenient if you have two smartphones, for example.

- Audio-Technica does not guarantee the operation of all combinations of Bluetooth devices.

Connecting using multipoint

1 Pair with the first Bluetooth device.

2 After pairing with the first device, turn off its Bluetooth feature.

3 Pair with the second Bluetooth device.

4 Turn on the Bluetooth feature of the first Bluetooth device.



- If the product does not connect, restart its power.
- Up to two Bluetooth devices can be connected at the same time with multipoint. To connect a third Bluetooth device, disconnect one of the connected devices.

Wearing the product

Put the side of the product marked "L" (LEFT) onto the left ear and the side marked "R" (RIGHT) onto the right ear, slide the slider up and down so that the earpads cover the ears, and then adjust the headband.

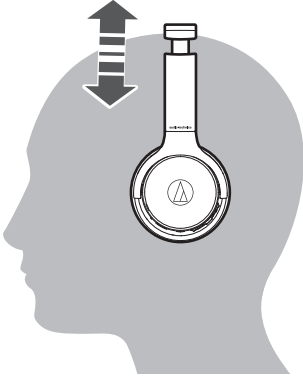

Swivel mechanism

You can fold the housing so that it lies flat.

- The swivel mechanism cannot rotate more than 90 degrees. Do not apply excessive force.

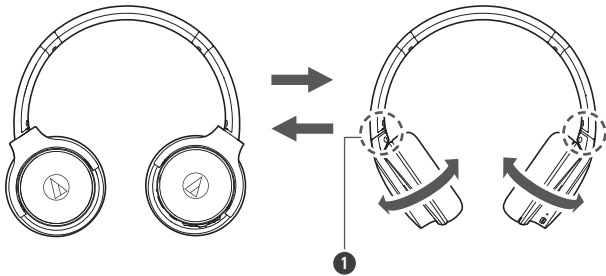

1 Joint

Using the product

The product can use Bluetooth wireless technology to connect to your device and play music, receive phone calls, etc. Use the product for whichever of these purposes suits your needs. Note that Audio-Technica cannot guarantee the operation of displays, such as the battery level display, or applications via Bluetooth devices.

Listening to music

To connect for the first time, pair the product and your device via Bluetooth wireless technology. If you have already paired the product and your Bluetooth device, turn on the Bluetooth device's Bluetooth connection before turning on the product.

Use your Bluetooth device to start playback, referring to the device's user manual as necessary.

1 Turn on the product and place the product on your ears.

2 Start music playback on your Bluetooth device.

3 Adjust the volume by pressing the volume buttons (+/-).

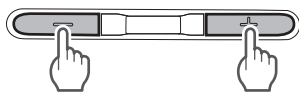

4 Press the power supply / control button to stop playback.

- Playback will be started or stopped with every press.

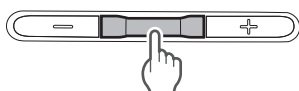

Power supply / control button operation

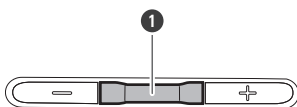

1 Power supply / control button

Operation	Function
Press	Starts or pauses playback.
Press (twice)	Depending on the connected device, activates the device's speech recognition function (such as Siri for compatible iOS devices).

- The controls explained above may not be available on some smartphones.

Volume button operation

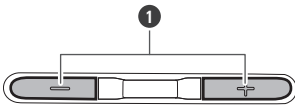

1 Volume buttons

Operation	Function
Press	Increases/decreases the volume by 1 level. ^{[1][2]}
Press and hold (about 2 seconds)	Plays the next track. Plays the previous track / returns to the start of the track.

[1] A beep is heard when the volume is at the maximum or minimum level.

[2] The volume control of some Bluetooth devices may not work well with the product.

- The controls explained above may not be available on some smartphones.

Talking on the phone

If your Bluetooth device supports telephone features, you can use the product to talk on the phone.

1 Turn on the product and place the product on your ears.

2 Make/receive calls with your Bluetooth device.

- When your Bluetooth device receives a phone call, the product sounds a ringtone.
- If a call is received while you are listening to music, music playback is paused.

3 Adjust the volume by pressing the volume buttons (+/-).

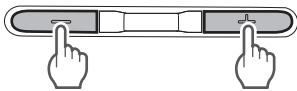

4 Press the power supply / control button to end the call.

- If the call was received while listening to music, playback is resumed.
- Music playback may not be resumed on some Bluetooth devices. In this case, music playback must be started manually.



Using the product

Power supply / control button operation

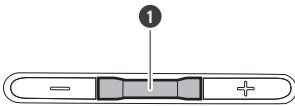

1 Power supply / control button

Operation	Function
Press	Receiving a call: Answers the call. Making a call: Cancels the call. During a call: Ends the call.
Press and hold (about 2 seconds)	Receiving a call: Rejects the call. Making or during a call: When pressed and held, the call switches between the product and your Bluetooth device. ^[1]

[1] When you hear a confirmation tone, release the power supply / control button.

- The controls explained above may not be available on some smartphones.

Volume buttons

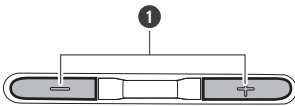

1 Volume buttons

Operation	Function
Press	Increases/decreases the call volume by 1 level.

- The controls explained above may not be available on some smartphones.

Low latency mode

Low latency mode reduces sound delay when playing games or watching videos.

- Bluetooth communication can be easily affected by obstacles and radio wave conditions.

1 Press the power supply / control button three times in a row.

» With every three presses, the voice guidance will play the message “Low latency mode” or “Low latency mode off”, and low latency mode will be switched ON/OFF.



- Low latency mode cannot be switched ON/OFF during a call or during voice input using the speech recognition feature.

Using the product

Wired connection (playthrough function)

The product has a playthrough that allows you to use it as portable headphones and play back music even when there is no battery power. You can connect the connector plug of the included cable to the product's connector jack, and then connect the input plug into a portable audio player. The buttons on the headphone cannot be used for operation when using a wired connection.

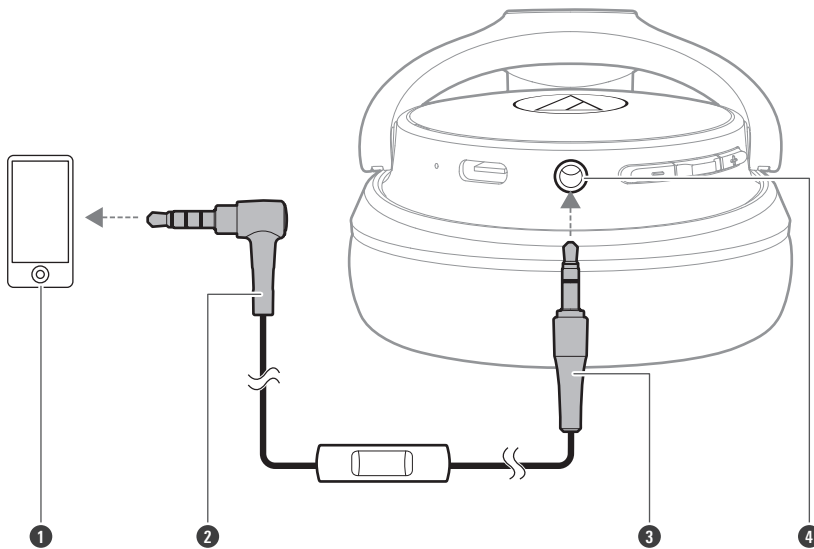

- 1 Smartphone, portable audio player, etc.
- 2 Input plug
- 3 Connector plug
- 4 Connector jack

Using the cable with in-line mic and control

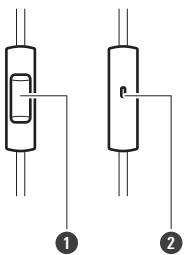

- 1 Control button
- 2 Microphone

Using the product

Operation	Function
Press	Starts or pauses playback. Receiving a call: Answers the call. Making a call: Cancels the call. During a call: Ends the call.
Press and hold (about 2 seconds)	Receiving a call: Rejects the call. Depending on the connected device, activates the device's speech recognition function (such as Siri for compatible iOS devices).
Press (twice)	Plays the next track.
Press (three times)	Plays the previous track / returns to the start of the track.

- The controls explained above may not be available on some smartphones.
- Audio-Technica does not provide support for smartphones used by customers.

Auto power off function

The product automatically turns off after 5 minutes of not being connected to a device. The product also automatically turns off after 5 minutes in the "Waiting to be connected" status.

Indicator lamp display

The indicator lamp of the product indicates the product's status.

Pairing

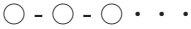
Status	Indicator lamp display pattern
Searching for devices	 Flashing white (gradually lighting up)

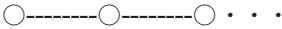
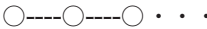
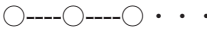

Connecting

Status	Indicator lamp display pattern
Waiting to be connected	 Flashing white in 8-second intervals (gradually lighting up)
Connecting	 Flashing white in 4-second intervals
Music is playing	 Flashing white in 4-second intervals (gradually lighting up)

Battery level

Status	Indicator lamp display pattern
Battery level is low	 Flashing red 3 times in 4-minute intervals

Charging

Status	Indicator lamp display pattern
Charging	 Lit red
Fully charged	 Off
Charging error	 Flashing red

Voice guidance

The product plays English voice guidance in the following situations.

Situation	Voice guidance
Power is turned on	Voice guidance varies depending on the battery level: Battery level high Battery level medium Battery level low
Bluetooth is connected	Bluetooth connected
Bluetooth is disconnected	Bluetooth disconnected
Low latency mode ON	Low latency mode
Low latency mode OFF	Low latency mode off
Music is played	Play
Music is paused	Pause
Battery level is low	Low battery

Cleaning

Get into the habit of regularly cleaning the product to ensure that it will last for a long time. Do not use alcohol, paint thinners, or other solvents for cleaning purposes.

- Use a dry cloth to clean the headphones.
- To clean the earpads and headband, wipe with a dry cloth. Earpads and headband may fade if sweat or water dries on them. If the earpads and headband get wet, we recommend wiping them with a dry cloth and allowing them to dry in the shade.
- Immediately wipe off any moisture such as sweat from operating areas such as the buttons. Failure to do so may result in a malfunction due to corrosion.
- Wipe away any perspiration or dirt from the cable with a dry cloth immediately after use. Failure to clean the cable may cause it to deteriorate and harden over time, resulting in malfunction.
- Wipe the cable's USB plug with a dry cloth if dirty.
- Wipe the cable with in-line mic and control's plug with a dry cloth if dirty. Failure to clean the plug may cause sound skipping or noise.



- If the product will not be used for an extended period of time, store it in a well-ventilated place free from high temperatures and humidity.
- Earpads are consumable parts. The earpads deteriorate over time due to use or storage. Contact your local Audio-Technica dealer for earpads replacement or other repairs.

Forced pairing mode / reset

If the product does not connect to a device (forced pairing mode)

If pairing cannot be cancelled or is not successful, you can use forced pairing mode to perform pairing again.

- 1** With the product turned on, press and hold (about 6 seconds) the volume buttons (+/-) at the same time.

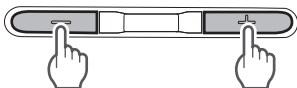

» The product will switch to the "searching for devices" (pairing mode) state and you will be able to pair with your desired Bluetooth device.

If the product operates abnormally (reset)

Reset the product.

- 1** With the product turned on, press and hold (about 6 seconds) the volume buttons (+/-) at the same time.

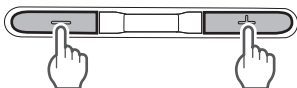

- 2** Make sure the indicator lamp is flashing rapidly in white, and press and hold the power supply / control button and the volume up button (+) at the same time (for about 6 seconds).

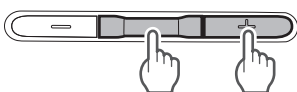

» The indicator lamp will light in pink, and after the product restarts, reset is complete.

- 3** Remove the product from the list of registered devices on your Bluetooth device.
- 4** Pair the product again.

Troubleshooting

? Power is not supplied

- Charge the product.

? Unable to pair

- Confirm that the Bluetooth device communicates using Ver. 2.1+EDR or higher.
- Place the product and the Bluetooth device within 1 m (3.3') of each other.
- Set the profiles for the Bluetooth device. For procedures on how to set profiles, refer to the Bluetooth device's user manual.
- Remove the pairing information for the Bluetooth device then pair the product with this device again.
- Make sure you are not connected to any other previously connected Bluetooth device. If so, disconnect the product using the previously connected Bluetooth device, and then select the product on the Bluetooth device being connected to. Use forced pairing mode if you are unable to disconnect from a previously connected Bluetooth device. For details, refer to "If the product does not connect to a device (forced pairing mode)" (p. 23).
- Reset the product if it cannot be unpaired, connected, or does not operate as expected even after trying all other solutions. For details, refer to "If the product operates abnormally (reset)" (p. 23).

? No sound is heard / Sound is faint

- Turn on the power of the product and the Bluetooth device.
- Turn up the volume on the product and the Bluetooth device.
- Make sure that the product and Bluetooth device are connected by the A2DP (or audio connection).
- Disable pairing for the product and the Bluetooth device, then pair the product with this device again.
- Move away from obstacles between the product and the Bluetooth device, such as people, metal, or walls, and place the product and device closer together.
- Switch the sound output of the Bluetooth device to the product.

? Sound is distorted / Noise is heard / Sound cuts out

- Turn down the volume on the product and the Bluetooth device.
- Keep the product away from devices that emit radio waves such as microwaves and wireless routers.
- Keep the product away from TVs, radios, and devices with built-in tuners. These devices can also be affected by the product.
- Turn off the equalizer settings of the Bluetooth device.
- Remove obstacles between the product and the Bluetooth device and place them closer together. For details, refer to "For a more comfortable Bluetooth communication experience" (p. 5).

Cannot hear the voice of the caller / Voice of the caller is too quiet

- Turn on the power of the product and the Bluetooth device.
- Turn up the volume on the product and the Bluetooth device.
- Confirm that the product and Bluetooth device are connected via HFP/HSP (or phone connection).
- Disable pairing for the product and the Bluetooth device, then pair the product with this device again.
- Switch the sound output of the Bluetooth device to the product.

The product cannot be charged

- Securely connect the included USB charging cable and charge the product.
- Charge the product in a well-ventilated place (10 to 35°C (50 to 95°F)) away from direct sunlight.



- For details about how to operate your Bluetooth device, refer to the device's user manual.

Specifications

Headphones

Type	Closed-back dynamic
Driver	40 mm
Sensitivity	105 dB/mW
Frequency response	5 to 32,000 Hz
Impedance	32 ohms

Microphone (headphones)

Type	Electret condenser
Polar pattern	Omnidirectional
Sensitivity	-42 dB (1 V/Pa, at 1 kHz)
Frequency response	50 to 4,000 Hz

Microphone (cable)

Type	Electret condenser
Polar pattern	Omnidirectional
Sensitivity	-44 dB (1 V/Pa, at 1 kHz)
Frequency response	100 to 10,000 Hz

Communication specifications

Communication system	Bluetooth version 5.0
Maximum RF output	10 mW EIRP
Maximum communication range	Line of sight - approx. 10 m (33')
Frequency band	2.402 GHz to 2.480 GHz
Modulation method	GFSK, Pi/4DQPSK, 8DPSK
Spread spectrum method	FHSS
Compatible Bluetooth profiles	A2DP, AVRCP, HFP, HSP
Supported codec	SBC
Supported content protection method	SCMS-T
Transmission band	20 to 20,000 Hz

Specifications

Other

Power supply	DC 3.7 V lithium polymer battery
Charging time	Approx. 4 hours ^[1]
Operating time	Continuous transmission time (music playback): Max. approx. 60 hours ^[1]
Weight	180 g (6.35 oz)
Operating temperature	5°C to 40°C (41°F to 104°F)
Accessories	USB charging cable (30 cm (12"), USB Type-A / USB Type-C), Cable with in-line mic and control (1.2 m (3.9')/3.5 mm (1/8") gold-plated stereo mini-plug (4 pole/L-shaped))
Sold separately	Earpad, Cable with in-line mic and control

[1] The figures above depend on operating conditions.

- For product improvement, the product is subject to modification without notice.

Trademarks

- The **Bluetooth**[®] word mark and logos are registered trademarks owned by Bluetooth SIG, Inc., and any use of such marks by Audio-Technica Corporation is under license. Other trademarks and trade names are those of their respective owners.
- USB Type-C[™] is a trademark of USB Implementers Forum.
- Siri is a trademark of Apple Inc. registered in the United States and other countries.
- Google and Android are trademarks of Google LLC.

株式会社オーディオテクニカ

〒194-8666 東京都町田市西成瀬2-46-1
www.audio-technica.co.jp

Audio-Technica Corporation

2-46-1 Nishi-naruse, Machida, Tokyo 194-8666, Japan
www.audio-technica.com
©2021 Audio-Technica Corporation
Global Support Contact: www.at-globalsupport.com